



December 2, 1999

SAFETY-KLEEN CORP.

CERTIFIED MAIL
RETURN RECEIPT REQUESTED
P 074 852 299

Mr. James Bearzi
New Mexico Environment Department
Hazardous and Radioactive Materials Bureau
P. O. Box 26110
Santa Fe, NM 87502



RE: Class 1 Permit Modification
Safety-Kleen, Farmington
EPA ID # NMD980698849

Dear Mr. Bearzi:

Safety-Kleen is requesting a Class 1 permit modification (40 CFR §270.42(a)) to the RCRA permit for the TSDF in Farmington, New Mexico. The enclosure, A Study of Drum Cleaning with Continued Use Solvent, explains why the change is necessary and provides applicable required information as to what changes must be made to existing permit conditions. The study outlines the process, the equipment, schematics for connection to the existing system and engineering data regarding the cleaning process.

If you should have any questions regarding the information submitted for the permit modification, please do not hesitate to call me at 602-462-2315. Your favorable consideration is appreciated.

Sincerely,

Lon Stewart
Regulatory Compliance Manager

enclosure



Alan A. Manteuffel Technical Center

Study of Drum Cleaning with Continued Use Solvent

**Robert Janicki & Dennis Brinkman
Safety-Kleen Corp.**

September 24, 1997

P. O. Box 92050
Elk Grove Village, IL
60009-2050

12555 W. Old Higgins Road
Elk Grove Village, IL 60007
Telephone: 773/825-7000
Fax: 773/825-7850

Study of Drum Cleaning with Continued Use Solvent

**Robert Janicki & Dennis Brinkman
Safety-Kleen Corp.**

INTRODUCTION

This report provides the results of an engineering study of drum cleaning at Safety-Kleen branch facilities. The study established a standard system to assure adequate cleaning of drums prior to their return to customers. Drums will be cleaned with solvent that has been initially used by our customers and returned to our branches for continued-use as a cleaning solvent. After use as a drum washing agent, the material will be recycled.

Parts washing involves the use of various cleaning agents to remove deposits or surface contamination from hard surfaces. Over the years, the primary agent has been a hydrocarbon distillate variously called mineral spirits, Stoddard Solvent, or petroleum naphtha. During initial use, this solvent becomes unacceptable for the intended application and fresh solvent is provided. However, the partially used solvent still retains the capacity for less rigorous cleaning applications, such as drum washing.

This multiple use of the solvent allows maximum value out of this commodity.

DRUM WASHING SCENARIOS

Existing Drum Washer/Dumpster System

For many years, Safety-Kleen has used a system that combines drum washing within a large trough that is used as a receptacle for receiving parts washer solvent returned from our customers. The trough portion of this unit is typically 1.5 ft wide x 3 ft. long x 1.5 ft. deep. It allows easy access for the emptying of drums and typically contains up to 40 gallons of solvent.

The drum washer mechanism sits to the side of the dumpster trough and within a unified containment area (see Figure 1). The complete system is 3 ft. wide x 5 ft. long x 6 ft high. As shown in Figure 2, it is fitted with a brush and nozzle assembly designed to wash bottom interior and exterior sidewalls of drum. Solvent is pumped from the bottom of this trough to a nozzle that sprays solvent inside drums that rotate around a large brush that scrubs the inside surface.

A maximum volume of 40 gallons is retained in the bottom of the drum washing unit. A float switch controls a second pump that moves excess solvent to a storage tank. This solvent is then transported to a recycling plant.

New Continued Use System

Continued use material will be deposited in a 200-gallon open top vessel is (3 ft. wide x 4 ft. long x 5 ft. high) which has been fitted with a sloped bottom directed to a centered 1 1/2" threaded outlet. This tank has a full lid which is closed when not in use and is held open with a fusible-link for emergency closure during use. As shown in Figure 3, solvent for drum washing is taken preferentially from this dumpster until it is empty. This vessel is the primary source of drum washing solvent. When this vessel is empty, solvent residing in the bottom of the main dumpster is recirculated through the drum washer for any remaining requirements.

EQUIPMENT DESCRIPTION

Pumps

This system utilizes two ITT Marlow pumps (Model 1½HR49EC) which are 1½-inch open impeller centrifugal-type units powered by a 1½ HP (3450 RPM) motor. These pumps are specially useful for handling liquids with substantial solids loading.

Valves

The drum-washing solvent feed is controlled by two Watts Mfg. 1½" motor-driven ball valves (Model 1801-212). These valves are electrically-controlled. The valve between the final dumpster and the continued use solvent storage vessel are manually controlled by the operator from a control panel.

Nozzles

Two styles of nozzles are utilized in the drum washing assembly. The primary interior nozzle is a Spraying Systems; Model H-U ¼ 65200 Brass unit. The primary working dimension for this nozzle is its 1 1/32-inch orifice diameter, which yields a flowrate of 22 gal/min.

Three Model H-U ¼ 6510 Brass nozzles are utilized for exterior washing. The primary working dimension for this nozzle is a 3/16-inch orifice (this is drilled out from the normal 5/64-inch orifice), which yields a liquid stream instead of a mist spray to minimize air emissions.

Both of these nozzles were selected to give good area coverage with maximum cleaning efficiency without excessive vaporization.

Electrical Logic

The primary electrical circuit regulates the use of solvent from each dumpster unit. A single switch panel controls each valve simultaneously and has indicator lights to verify open (green)/ closed (red) positions. The drum washer pump will only operate when each valve is opposite each other, assuring that solvent cannot be mixed during the wash cycle (i.e., two illuminated green lights will lock out the washer pump).

A timer located in the drum washer control panel automatically stops the washer pump. The timer has a 1-9,999 second range. This assures that a specific volume of solvent is utilized during each wash cycle. Part of the objectives of this test was to establish the setting for this timer.

SYSTEMS OPERATION

The drum washer/dumpster and reuse dumpster are integrated by a pump dedicated to washing drums, as shown in the system layout in Figure 4. The two motor-driven valves control the inlet to this pump from each dumpster unit. The valves operate simultaneously opposite each other to maintain a sufficient solvent flow and specify which solvent is to be used for washing drums. The reuse dumpster is always the primary source. The washer pump is activated manually once a dirty drum is in place and is automatically stopped following the preset wash cycle period.

The second pump is dedicated to removing excess solvent from the drum washer/dumpster and is automatically controlled by a float switch mounted in the trough area of this unit.

EXPERIMENTAL RESULTS AND DISCUSSION

The volume of solvent required to remove sediment from parts washer drums is related to a time factor to be incorporated into the wash cycle since the solvent flowrate is constant and reproducible. All sediment settles to the bottom of a drum and a proper cleaning is considered accomplished when the interior drum bottom is visually free of any residue. It is extremely rare that the exterior is still dirty once the interior is clean.

Studies were performed at two locations to substantiate a time period required to obtain clean drums. The Safety-Kleen Branches at Elgin, IL and South Bend, IN are representative of all Safety-Kleen Branches, since all drum washer installations are identical. Approximately 100 drums were cleaned at each location to generate the data for this study.

In each test, drums were washed for a 10 second period and inspected. Additional cleaning was performed in 5 second intervals until each drum was finished. The following chart associates the percentage of drums determined to be clean to the required time to achieve the desired results.

In each test, the washer was metered at a 22 gal./min. flow rate. This was determined by extending the nozzle into a drum via a 1-inch diameter X 5-ft hose and measuring the volume using a drum and calibrated dip stick.

Table 1 presents the data for South Bend, IN.

% Clean Drum	Wash Time	Solvent Volume
31%	10 sec.	3.7 gal.
70%	15 sec.	5.5 gal.
88%	20 sec.	7.3 gal.
96%	25 sec.	9.2 gal.
100%	35 sec.	12.8 gal.

Table 2 presents the data for Elgin, IL.

% Clean Drum	Wash Time	Solvent Volume
35%	10 sec.	3.7 gal.
66%	15 sec.	5.5 gal.
92%	20 sec.	7.3 gal.
99%	25 sec.	9.2 gal.
100%	35 sec.	12.8 gal.

As can be seen, the data are very similar. By combining all of the data and utilizing the known flow rate to associate a solvent volume with each time interval, Table 3 presents both the time and solvent volume required to clean dirty solvent drums. If one assumes the goal is to only rarely run any drums through a second time, the timer will need to be set at 35 seconds and a total volume of solvent of around 13 gallons will be required. This is around the typical volume brought back in an average drum of dirty solvent.

% Clean Drum	Wash Time	Solvent Volume
33%	10 sec.	3.7 gal.
68%	15 sec.	5.5 gal.
90%	20 sec.	7.3 gal.
98%	25 sec.	9.2 gal.
100%	35 sec.	12.8 gal.

CONCLUSIONS

The average total flowrate for the drum washer is 22 gal/minute. Our study showed the time needed for cleaning all but the most highly contaminated drums was 35 seconds. Thus, 13 gallons of solvent per drum is required. When this continued use system is installed, all pumps, nozzles, and timers will be standardized to be identical to these operating parameters.

FIGURE 1

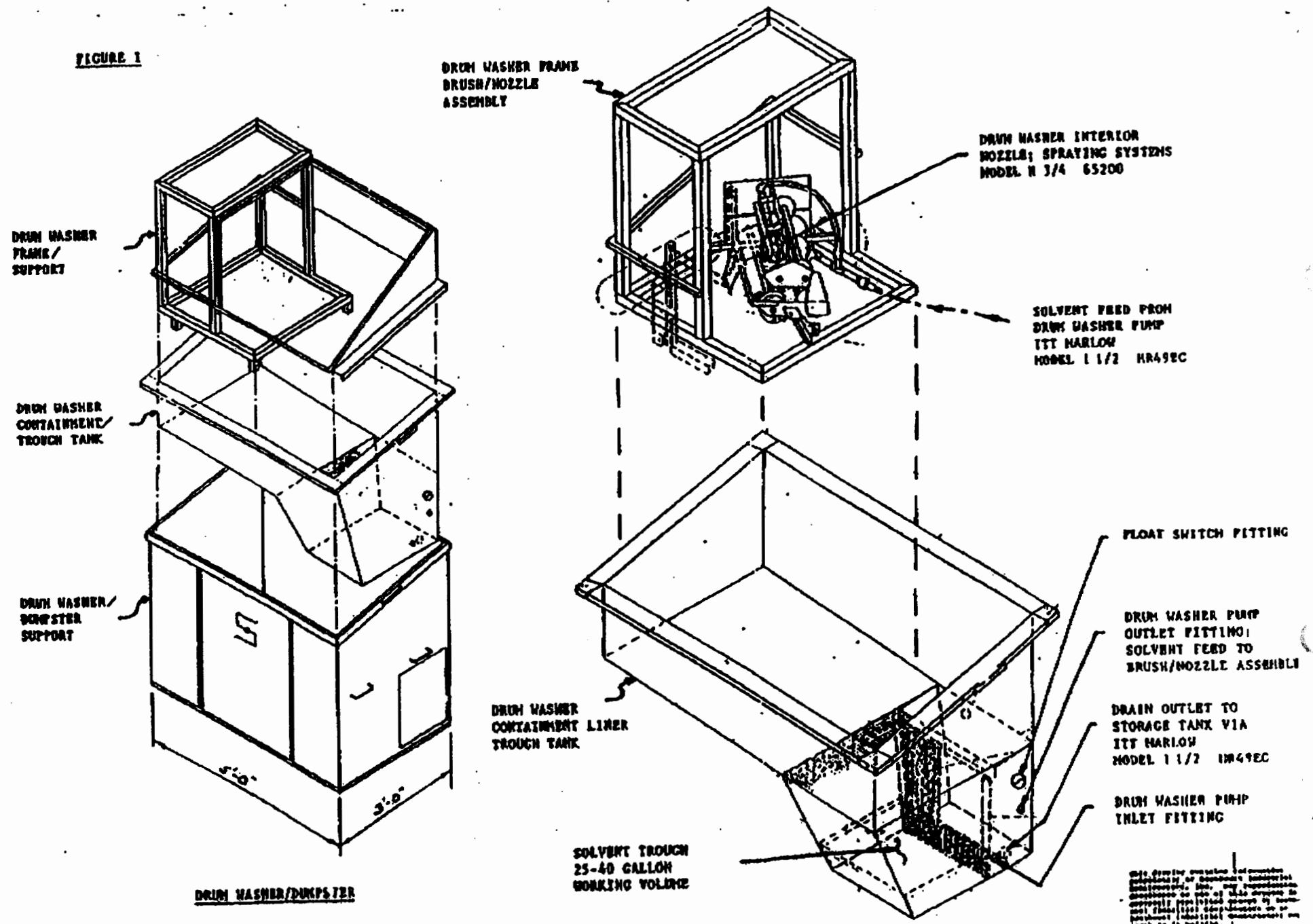

This drawing contains information furnished by or obtained indirectly from the customer. It is the property of the customer and is not to be distributed, copied, or used in any way without the express written consent of the customer. The customer is responsible for the accuracy of the information furnished and for the results obtained from its use.

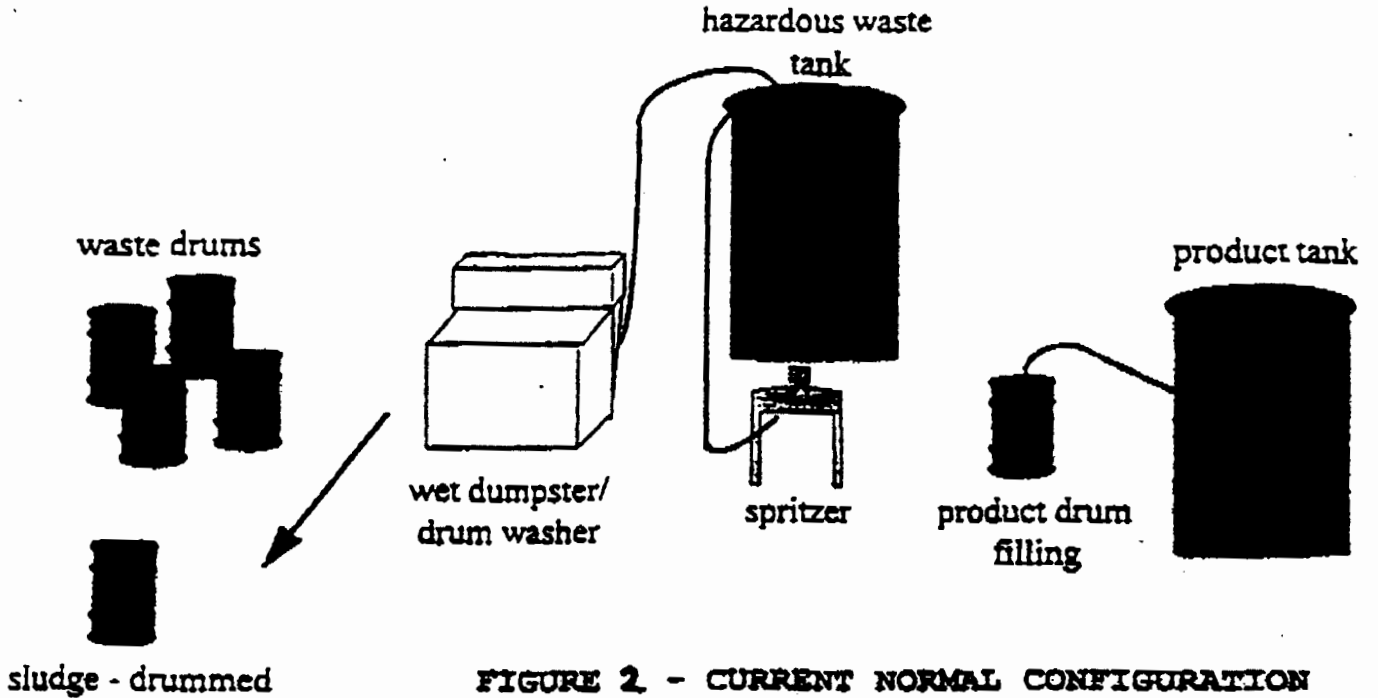

FIGURE 2 - CURRENT NORMAL CONFIGURATION

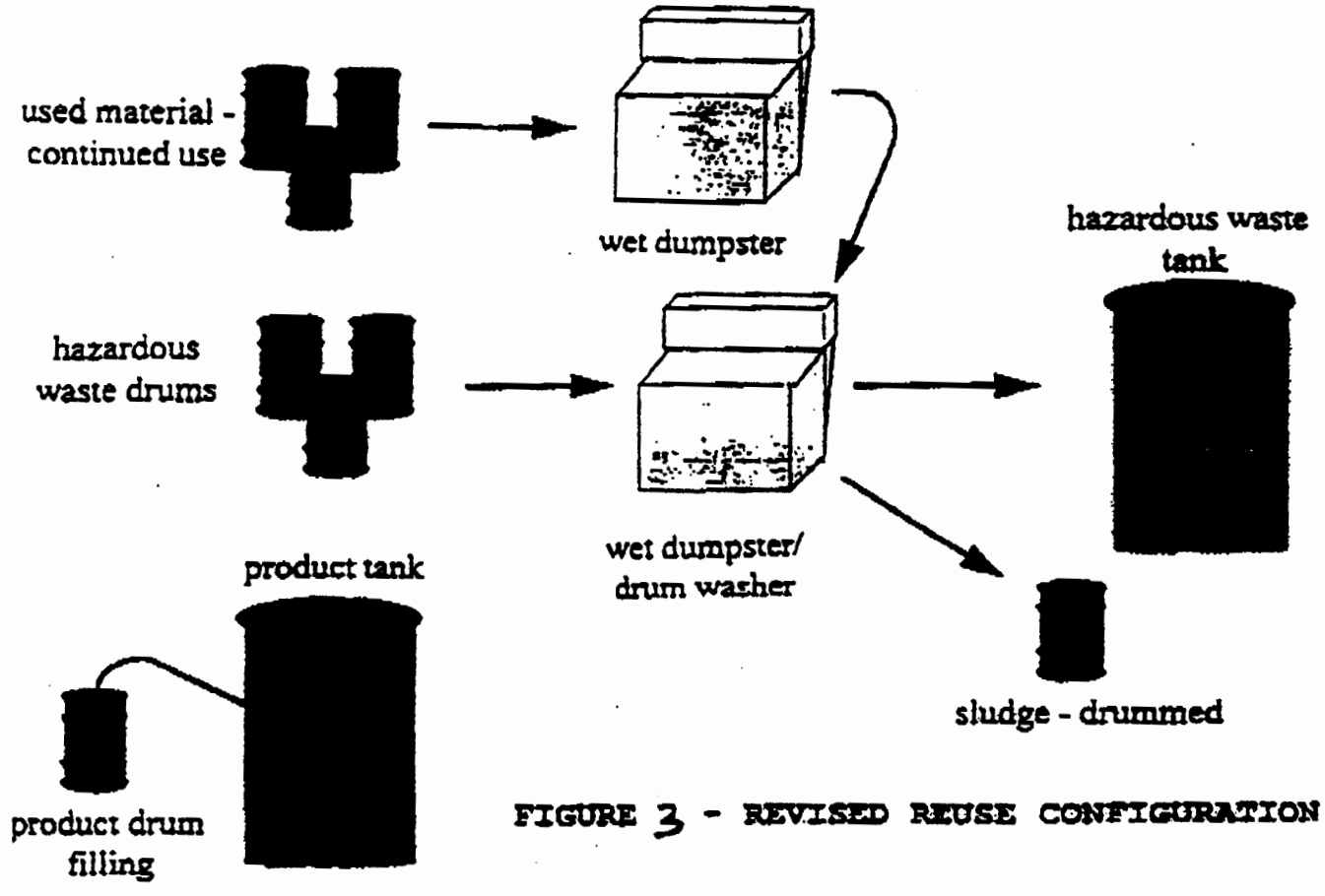
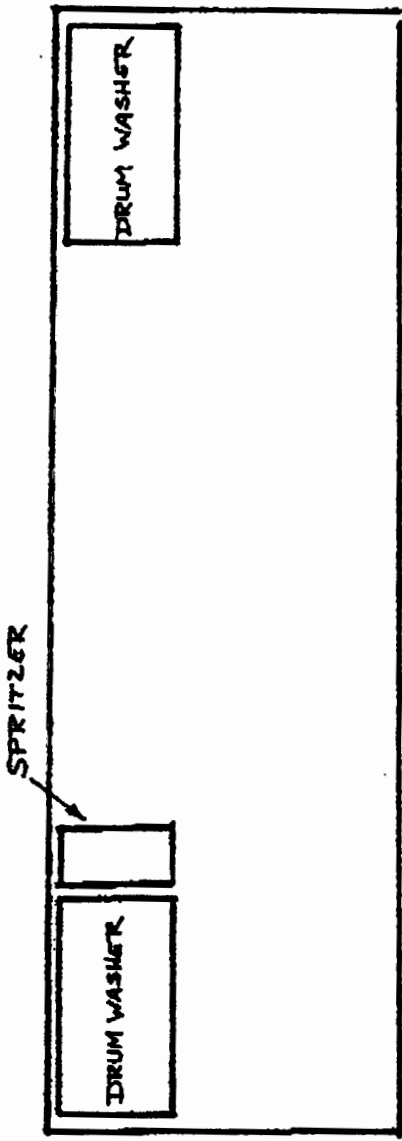

FIGURE 3 - REVISED REUSE CONFIGURATION

CONTINUED USE

R/F LAYOUT



CURRENT

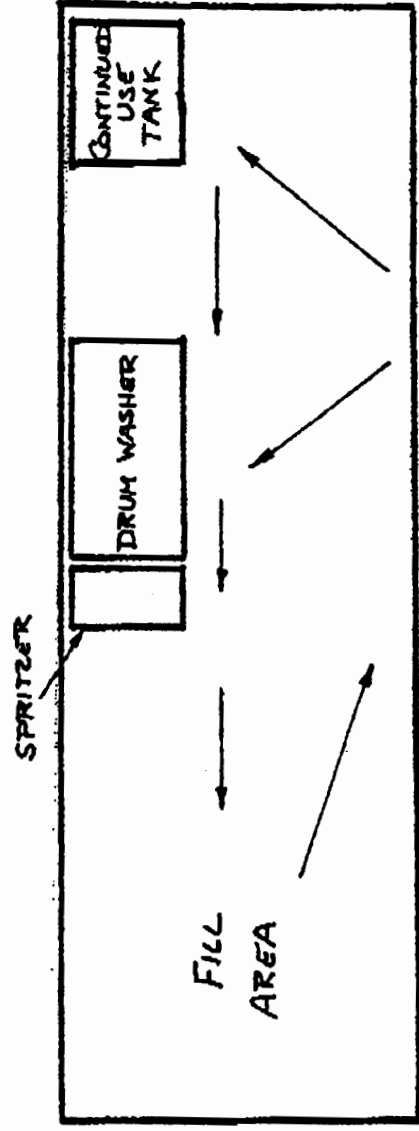

PROPOSED

FIGURE A

BARREL WASHER/ REUSE SOLVENT SUPPLY TANK PIPING SCHEMATIC

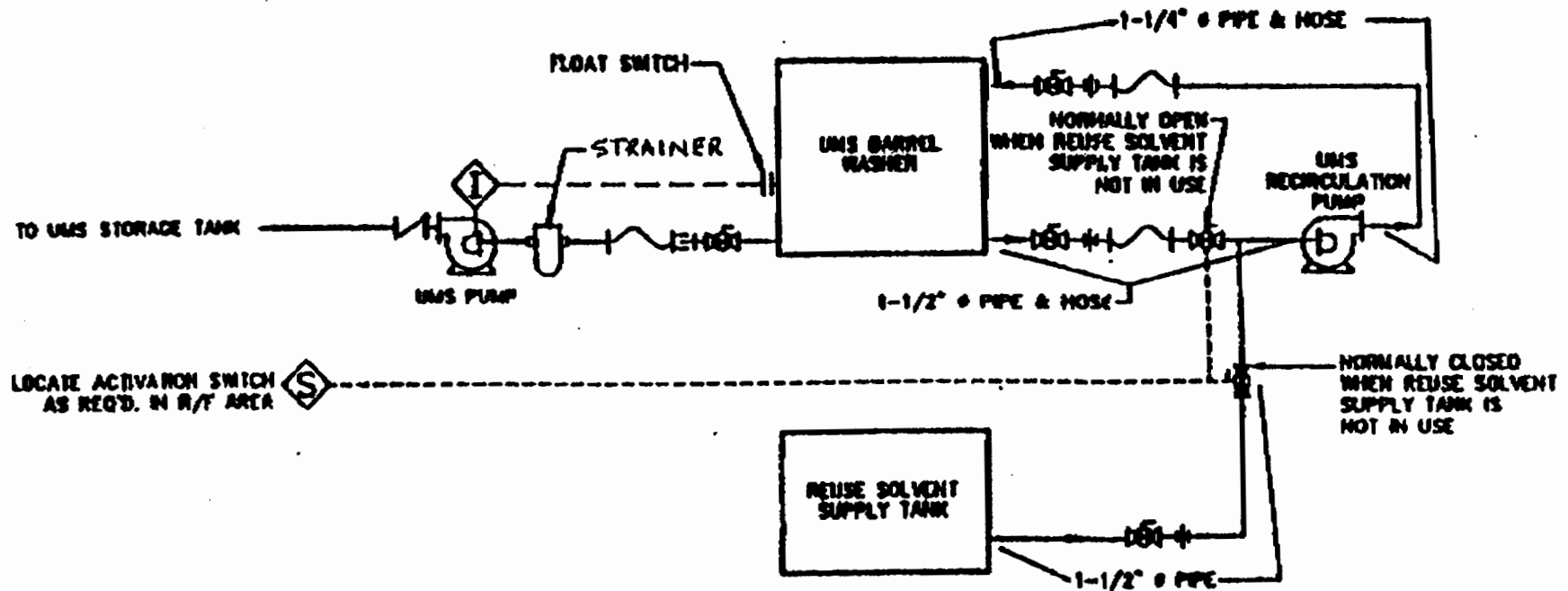

FIGURE 2

CONTINUED USE

R/F SCHEMATIC

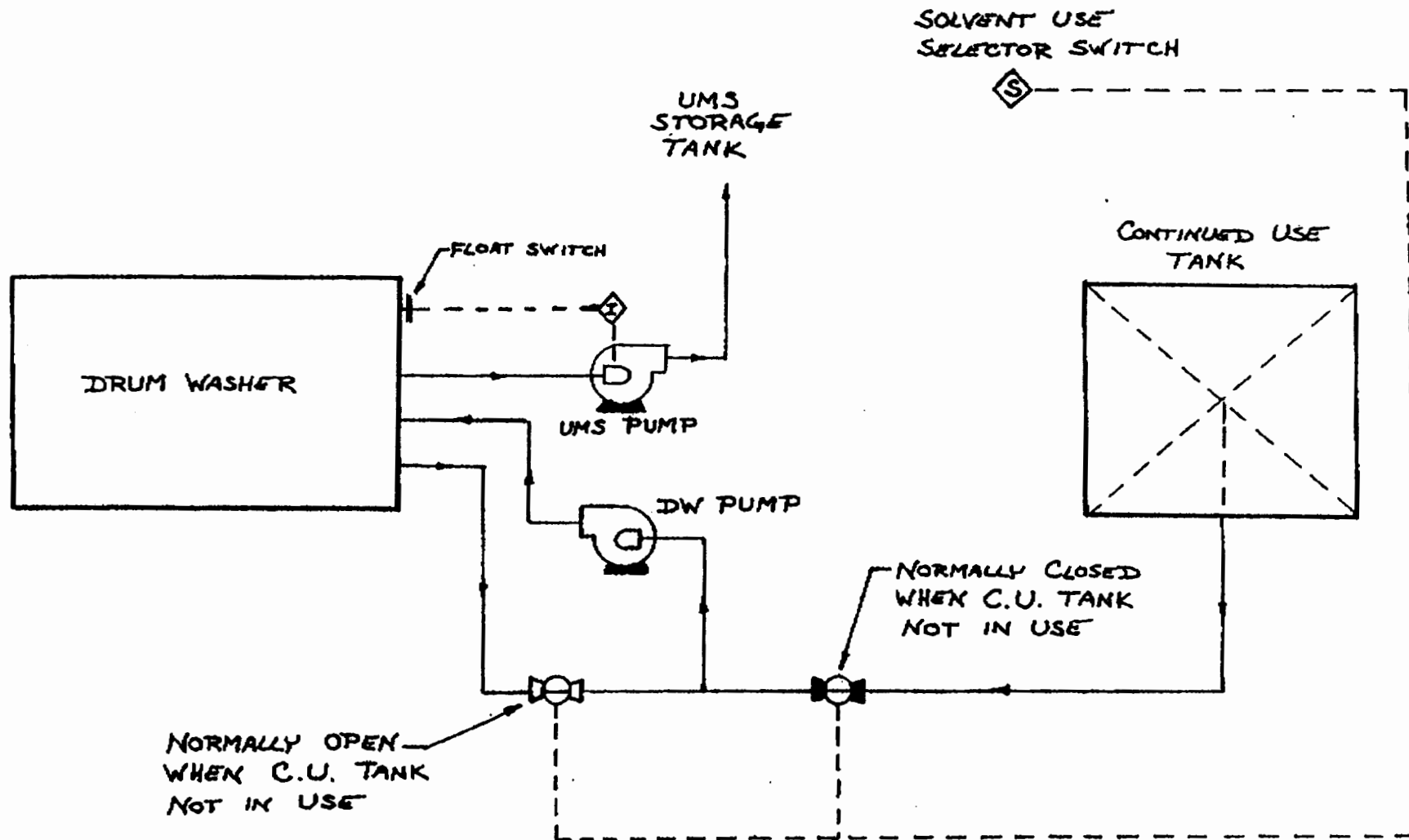

FIGURE 3

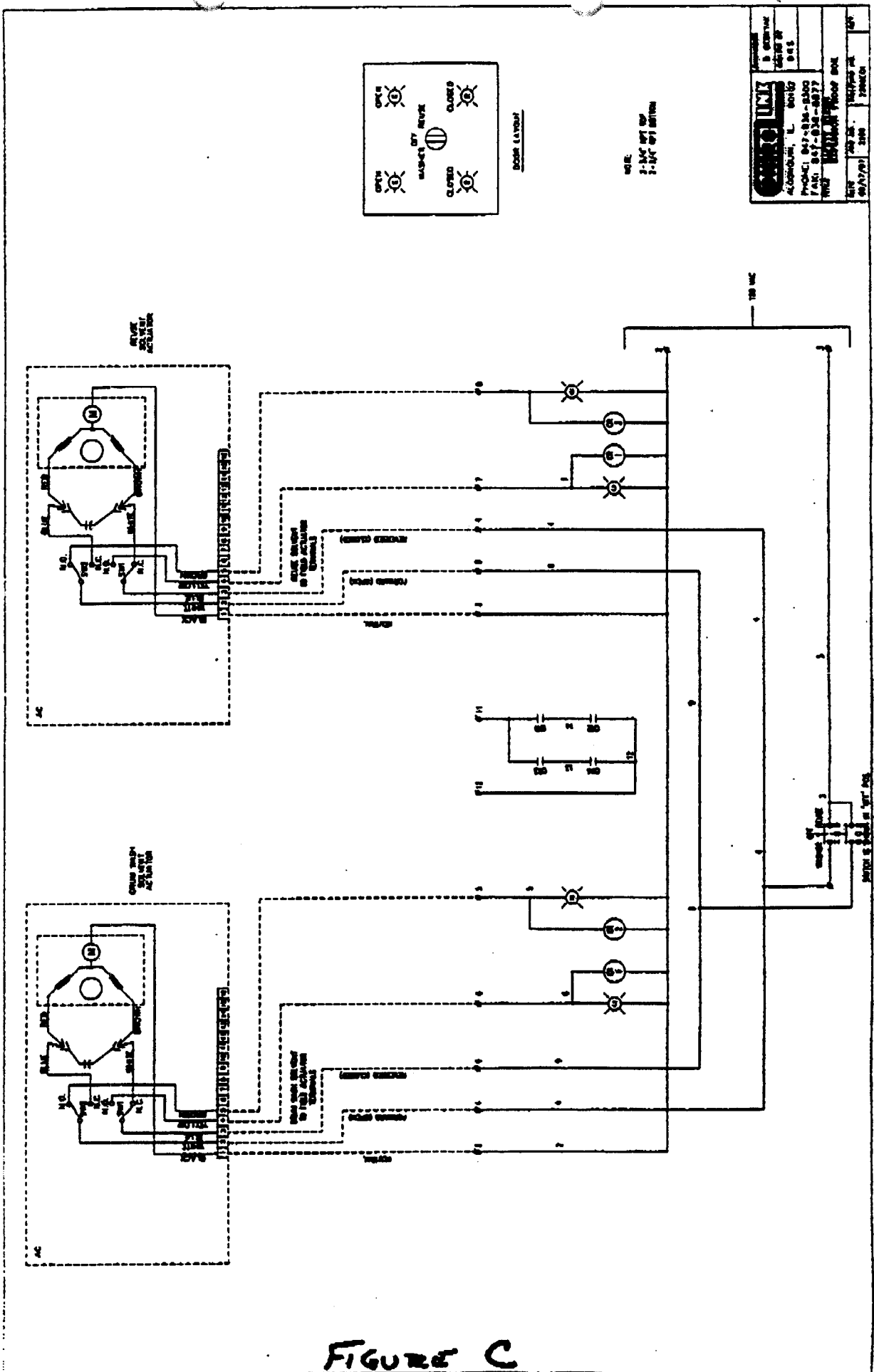

FIGURE C

WISHMEIER & ASSOCIATES

Structural • Architectural Engineers
119 N. Taylor Street • South Bend, Indiana 46601
Phone: (219) 234-3433 • Fax: (219) 234-3498



SAFETY-KLEEN DRUM WASHER TIMER SETTING RECOMMENDATION

=====

Location: SAFETY-KLEEN CORP.
2217 West Western Ave.
South Bend, IN 46601

Date: November 14, 1997

Safety-Kleen Corp. has hired the firm of Wishmeier & Associates to determine and certify the amount of time for activation of their drum washer machine. This letter will serve as written documentation of the results and the procedure used to determine the activation time.

Testing Method

The drum washer pumps cleaning solvent into the dirty drums through a nozzle while the drum is spinning. The pump is activated by a switch with a timer. Therefore, the amount of cleaning solvent used during a cycle is determined by the timer. Our task was to determine exactly how much solvent is sprayed out of the nozzle during a certain period of time, and then recommend a timer setting to deliver the desired 13 gallons of solvent per cleaning event.

The simple solution would have been to collect the solvent from the nozzle into a container and measure the volume used during a given time period. However, the nozzle location was too awkward to be able to collect the solvent into a container. Our solution was to measure the change in solvent level in the separate re-use tank before and after the pump had been activated. The actual dimensions of the re-use tank were measured so that change in solvent volume could be calculated. The amount of time that the pump was activated was determined with a stopwatch and the amount of solvent was measured in the re-use tank with a measuring stick calibrated for that purpose. Finally, the calculated volume of solvent was divided by the time to get the flow rate. Our sample calculations are shown below:

FIGURE D

Discussion

The employees of the South Bend, Indiana branch of Safety-Kleen were very helpful. Curt assisted us throughout the testing. At the time of this test we did not have the proper pipe fittings to connect a flexible hose and nozzle to the drum washer, so that we could directly fill and measure a 16 gallon drum. A separate re-use tank is used at this branch to supply the drum washer. With this in mind we used the method described above, measuring the change in fluid depth in the re-use tank, to determine the solvent volume pumped per unit of time.

The South Bend branch has a pump timer installed and operational.

Data was recorded for drum washer flow rate for one supply tank situation, that being when the drum washer pulls solvent from the re-use tank, which is separate from the drum washer.

Conclusions

Safety Kleen Corp. has notified us that they desire the drum washer to be activated long enough to deliver 13 gallons of solvent. The data table above shows a consistent flow rate of .37 gal/sec for four consecutive tests. Therefore, Wishmeier & Associates recommends that the pump timer be set for 35 seconds.

Testing by:

Certified by:

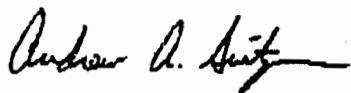

Andrew A. Switzer, E.I.T.
WISHMEIER & ASSOCIATES



Charles Keith Wishmeier, P.E.
WISHMEIER & ASSOCIATES

Sample Calculations

(Trial #2)

1. Calculate difference in solvent level:

$$7.75" - 6.25" = 1.50"$$

2. Calculate re-use tank area:

Tank: 36" x 48" with 3/32" steel walls

$$((36" - (2 \times 3/32")) \times (48" - (2 \times 3/32"))) \times (1 \text{ ft}^2/144 \text{ in}^2) = 11.89 \text{ ft}^2$$

3. Calculate volume of solvent used:

$$11.89 \text{ ft}^2 \times 1.5" \times (1 \text{ ft}/12") \times (7.48 \text{ gal}/\text{ft}^3) = 11.12 \text{ gal}$$

4. Calculate flow rate: Test cycle = 30 seconds

$$11.12 \text{ gallons} / 30 \text{ seconds} = .37 \text{ gal./sec.}$$

5. Calculate desired cycle time: Desired cycle = 13 gal.

$$13 \text{ gallons} / (.37 \text{ gal./sec.}) = 35 \text{ seconds}$$

Experimental Results

Trial #	1*	2	3	4	5
Initial Reading (inches)	9.50	7.75	6.25	4.75	3.25
Final Reading (inches)	7.75	6.25	4.75	3.25	1.75
Diff. (inches)	1.75	1.50	1.50	1.50	1.50
Total Volume (gal.)	12.97	11.12	11.12	11.12	11.12
Time (seconds)	30	30	30	30	30
Flow Rate (gal/sec)	.43	.37	.37	.37	.37
13 Gal. Time Needed (seconds)	30	35	35	35	35

*(Trial # 1 was ignored because its results were inconsistent.)

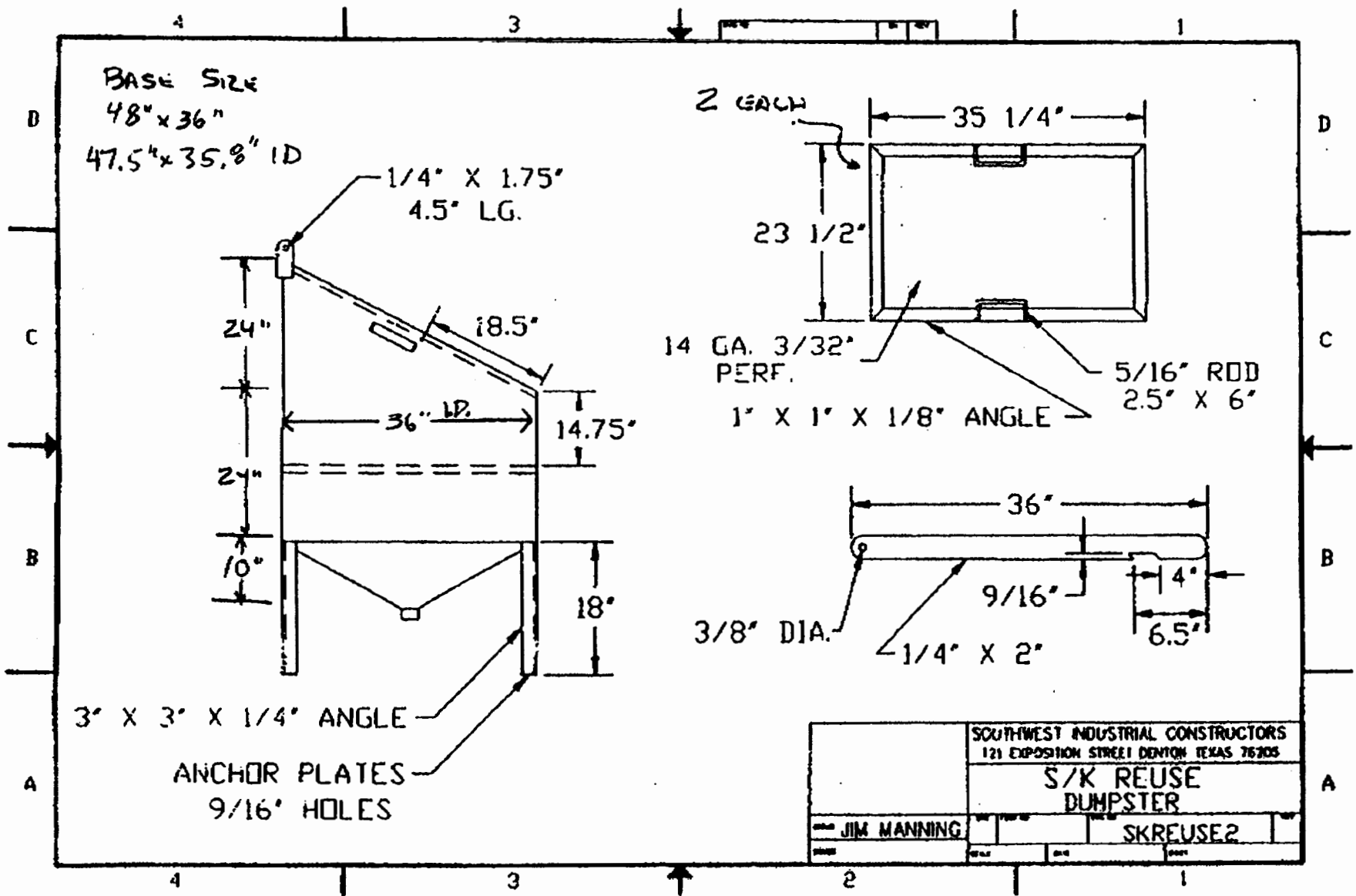

SOUTHWEST INDUSTRIAL CONSTRUCTORS 121 EXPOSITION STREET DENTON TEXAS 76205	
S/K REUSE DUMPSTER	
JIM MANNING	SKREUSE2